

# Safety Controller G9SP

Software-based standalone controller family



» Reconfigure to every need

» Flexible range suits any system

» Simple set-up and clear diagnosis

# Modular safety control

*The Omron G9SP is a new range of configurable safety controllers suited to the packaging, food, automotive components, injection moulding and printing industries. Because it isn't hardwired into your system, you benefit from a new flexibility, easily reconfiguring the unit when new safety features are added to your set-up. Three different models are available, with a range of I/O lines, so you can choose the most suitable for your system. Each one is compatible with the Omron configuration tool, recognised by industry as one of the most simple and accessible on the market.*

Omron G9SP: Global safety levels, lower TCO

- Configurable unit makes it ideal for building multiple stand-alone systems with the same specifications, or reconfiguring an existing set-up
- Handles function blocks for non-contact switches, single-beam sensors and safety mat inputs
- Faster and easier integration compared to hardwired systems
- Single simple GUI for configuration, simulation, testing and validation
- Greatly reduced set-up time
- EN ISO 13849-1 ready (PL/Safety category 4)







# Safety as standard

Omron has a complete range of safety solutions, from E-stop, door and limit switches to safety sensors and safety mats. The Omron G9SP is part of the most extensive offering in the industry, enabling Omron to supply a full variety of products to a range of applications worldwide.

Because operator safety is paramount in every system, we have invested our expertise in developing a full range of fully-compatible products. Our comprehensive selection of safety products help ensure maximum up-time, minimum interruption, and a fully-protected workplace.

What's more, our global network of offices, worldwide product availability, and unrivalled aftersales support give Omron customers a clear advantage. Help and expert advice on installation, operation and maintenance are always available, wherever you are.

Programmable	<div style="display: flex; justify-content: space-around;"> <div style="text-align: center;"> <p>Stand-alone Controller</p>  <p>G9SP</p> </div> <div style="text-align: center;"> <p>Safety Network Controller</p>  <p>NE1A</p> </div> </div>
Hard-wired	<div style="display: flex; flex-direction: column; align-items: center;"> <div style="text-align: center;">  <p>G9SX</p> </div> <div style="text-align: center; margin-top: 10px;">  <p>G9SA/SB</p> </div> </div>
<p>Small      &lt; Application size &gt;      Large</p>	

# Configurable, flexible, simple: the keys to safety

Every safety system relies on correct set up and the most suitable equipment. The Omron G9SP makes this easier than ever to do. The features of this product range give your new or existing set-up a range of benefits:

## Configurations matrix

- ❶ Safety controller G9SP
- ❷ Expansion I/O Units
- ❸ Memory cassette
- ❹ Ethernet option board
- ❺ RS-232C option board
- ❻ Compact non-contact door switch
- ❼ Safety mats
- ❽ Cj1/PLC
- ❾ Relays with forcibly guided contacts
- ❿ AC Servomotor/Drives G5 series
- ⓫ Configurator
- ⓬ Programmable terminal NB series

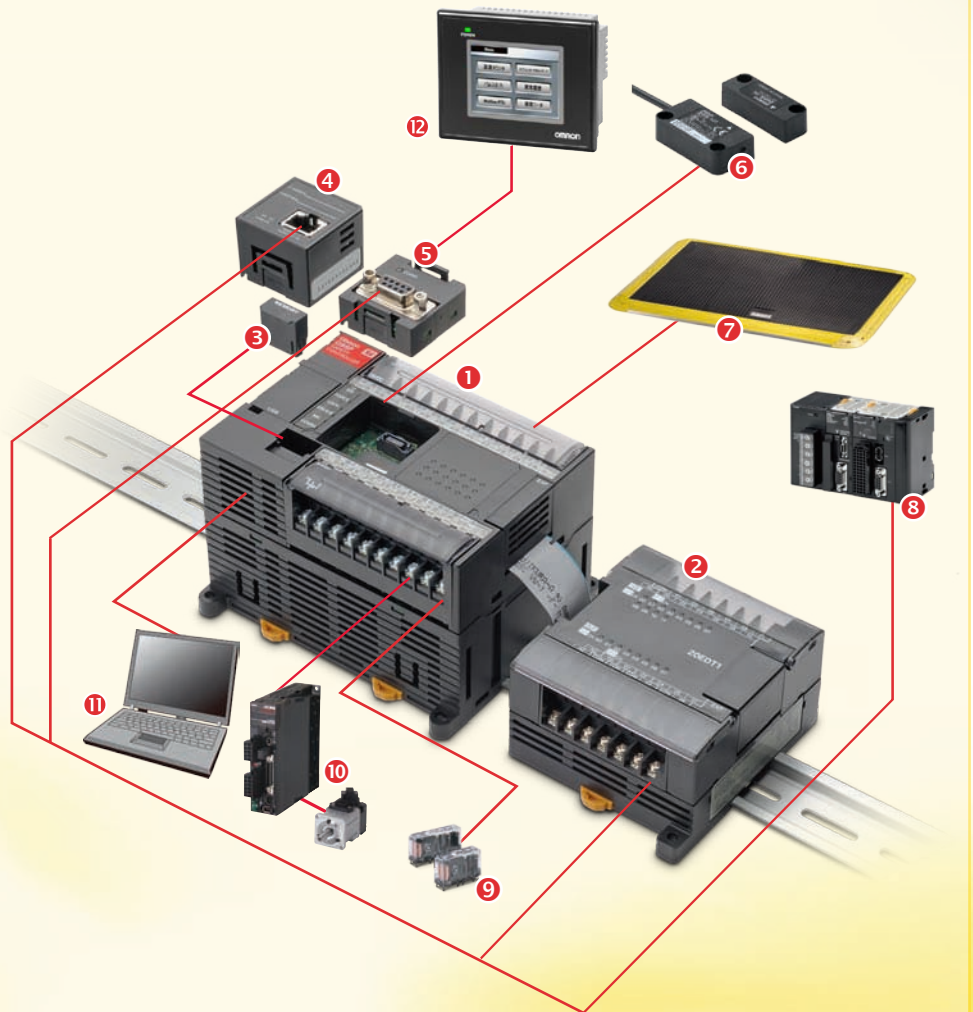



### Reconfigurable

With the Omron Configuration Tool, all aspects of input and output to the unit can be defined, simulated, tested and validated with an easy-to-use graphical user interface. If you are building with a make-once/use-many profile, configurations can be copied and applied to all systems. If you are reconfiguring an existing set-up, it's just as simple. When user needs change, it can be adapted quickly and easily to meet those needs.

### Flexible

Unlike hard-wired safety relays, the Omron G9SP can be reconfigured to multiple purposes. Because it is a solid-state, software-driven unit, all aspects of its operation can be reconfigured, with direct connection to non-contact switches or safety mats. Three I/O sizes are available: 20/8, 10/16 and 10/4. Covering the full range of typical small-to-mid sized systems, the Omron G9SP also comes with optional expansion units for standard I/O signals (12/8 and 0/32). Function blocks up to 128pcs complete this fully flexible range, so you can always be sure of a needs-match solution.

### Simple

Above all, the Omron G9SP range is supplied with simplicity. With the Omron Configuration Tool, you can quickly define all inputs, outputs, scope, testing, simulation, validation and operation of your system. On-screen text and icon-driven menus guide the user quickly through all aspects of set-up. Clear alerts and system status give any operator an instant overview at every stage of operation.

# Reconfiguration and reusability for real TCO savings

Modern production and automotive parts production lines must be flexible to cater to changing customer needs. This often means being able to change machine set-up at short notice, for custom jobs or additional requirements. With the Omron G9SP, it couldn't be easier. Function blocks can be redesigned and replaced using the simple GUI, swiftly incorporating any application changes or additions.

Even the most complex controls can be configured easily. Clear programming guidance is provided for new users, and modification and maintenance have been simplified too. Settings can be saved to Memory Cassette for off-line diagnostics, and any programming changes can be restored instantly into the Omron G9SP from the same memory cassette.



## **Safety in automotive component manufacture**

A change in machine operation can easily be covered by reconfiguring the application program. Certified function blocks for all kinds of safety functions are already on board and ready to use.

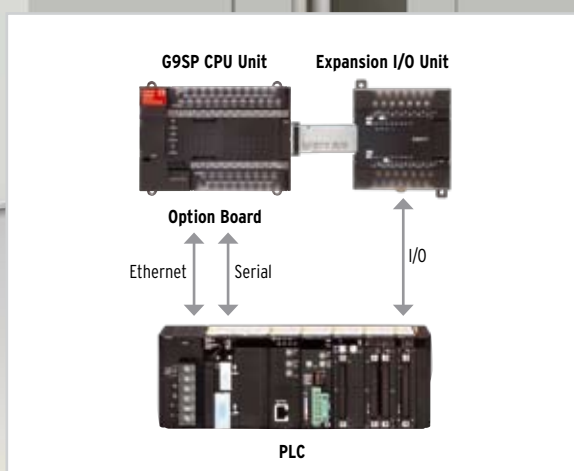

### Transparent diagnosis

Connection to PC/PLC via Ethernet makes the Omron G9SP fully accessible. Diagnosis, troubleshooting and program modification is simple, thanks to the USB programming interface and removable memory cassette.

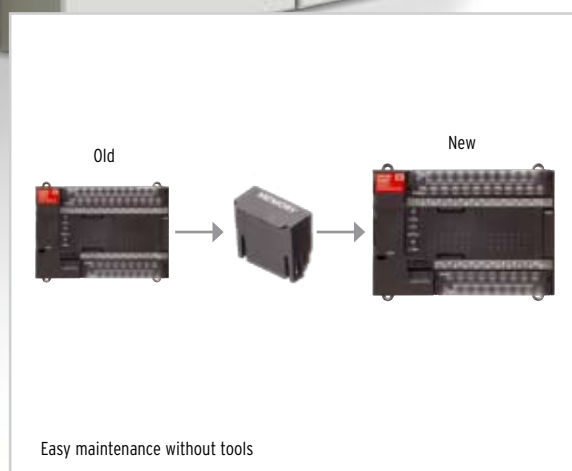

### Simple unit replacement

Because the Omron G9SP is a software-based controller, replacement is effortless. All settings, parameters and function blocks can be saved on a PC or stored on the Memory Cassette for easy transfer from one unit to another.

# Increased flexibility means decreased TCO

Modern packaging machines must be flexible to exactly match changing customer needs. With the Omron G9SP, application flexibility is built in. Choose from three standalone safety controller CPU types, then combine with any communication interface or 2 additional standard I/O signals. All G9SP units support direct connections of all kinds of safety sensors, including safety mats, non-contact door monitoring systems and single-beam sensors.

The Omron G9SP can be monitored and configured from a standard control console via Ethernet, serial board or standard I/O lines. For multiple applications of a single configuration, the Omron G9SP memory cassette usage. Which means that systems designers now only need to program the unit once, and use the memory cassette to install settings into each identical system.



## Presence detection

Omron has a variety of pressure safety mats in a range of sizes. Useful in any area where personnel may be at risk, mats instantly alert the Omron G9SP, which can immediately sound an alert or close down any dangerous machinery.

## Door monitoring

Direct connection of all Omron non-contact door monitoring solutions is supported by the G9SP family for maximum flexibility and minimum effort in setup and maintenance.



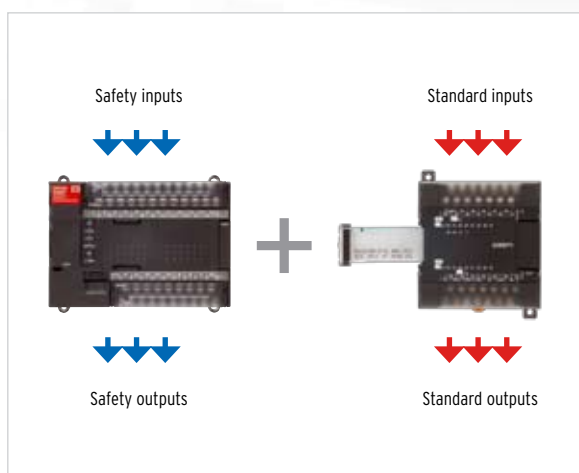

### Standard I/O

The G9SP family offers a range of easily-connected standard I/O units. This instant interface between safety and standard controls can be used to configure standard control signals into the complete safety configuration. Monitoring is simple too, via standard I/O units or Ethernet/serial boards for advanced monitoring.

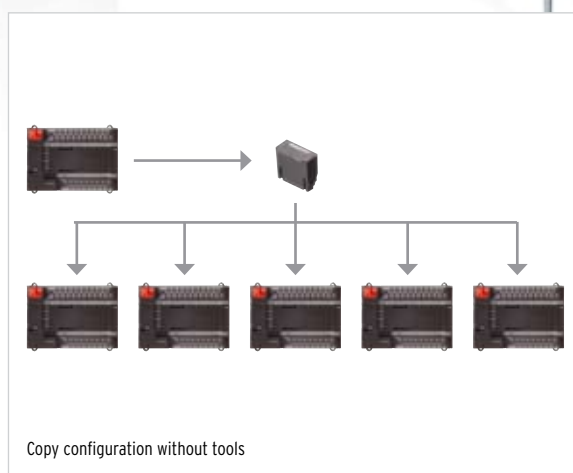

Copy configuration without tools

### Memory cassette for fast, simple ease of use

Designing safety systems is no longer the complex task it used to be. As well as a clear and simple programming interface, the Omron G9SP offers the advantage of memory cassette. Programs can be quickly modified and restored, with no additional effort.

# Configuration made simple

When designing or updating a safety system, configuration used to be one of the most time-consuming tasks. Not with the Omron G9SP.

Thanks to a clear and simple user interface, designing your system is easier than ever. Step-by-step instructions guide you through every aspect of design. A simulation tool allows you to test and correct settings before your system goes live. Then, thanks to user-defined function blocks, you can re-use any aspect of your design in future systems.





### Easy configuration

All safety functions are ready to use in the G9SP. Certified function blocks can be easily selected in the graphical user interface and customized to fit your application.

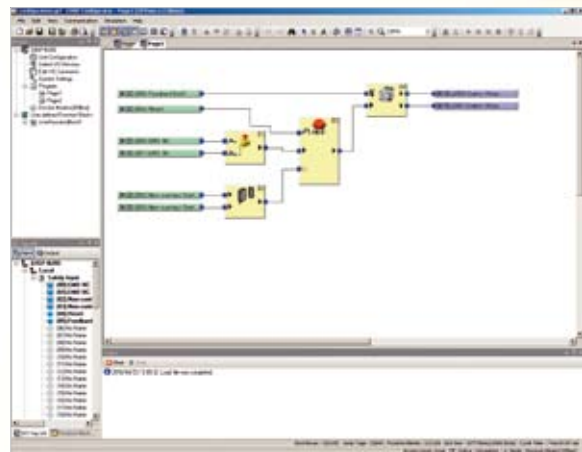

### User-defined function blocks

Approved configuration elements such as a tested door monitoring solution can be easily stored as a user defined function block and re-used in future projects. This minimises the time it takes to create a new system configuration.

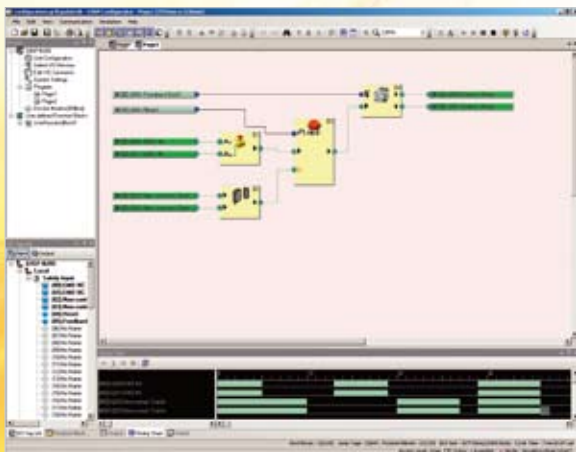

### Simulation

All functions can be tested and simulated in the Configuration Tool, so there's no unnecessary additional workload for the engineer. In addition, on-line diagnosis reduces debug time to a minimum during implementation in the machine control system.

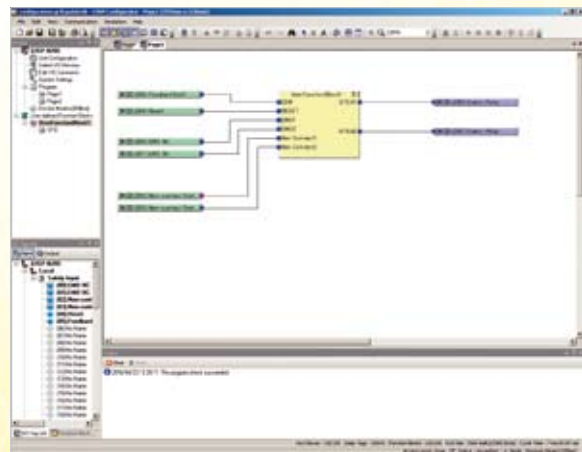

### Knowledge-building

Existing configurations are the basis for new projects. The G9SP Configuration Tool supports re-use of existing and proven know-how in safety control, as well as user-defined function blocks. Which means no more repetition of effort, instead a growing library of safety solutions.

# Safety Controller G9SP

## Easy programming for complex safety control

- Stand-alone Safety Controller for small and mid-sized machinery
- Three types of CPU with different I/O size to suit the application
- Four types of Expansion I/O Units for hard-wired diagnosis or standard signals
- Clear diagnosis and monitoring via Ethernet or Serial connection
- Various kinds of safety devices directly connectable like non-contact switches and safety mats
- Easy design, verification, standardization and reuse of safety control by unique programming software
- ISO 13849-1 (PLe/Category 4), IEC61508 (SIL3) certified

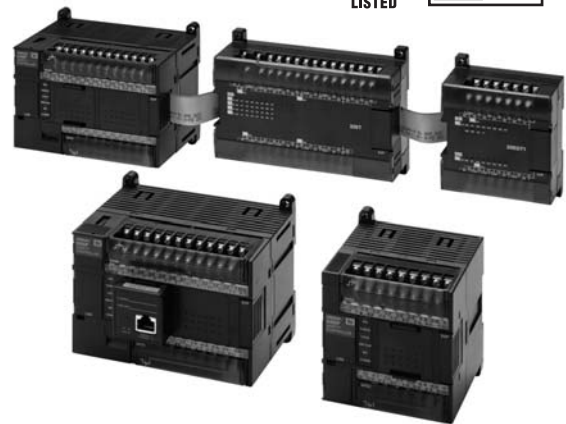

For the most recent information on models that have been certified for safety standards, refer to your OMRON website.

Refer to "Safety Precautions" on page 26.

## Example of the system configuration

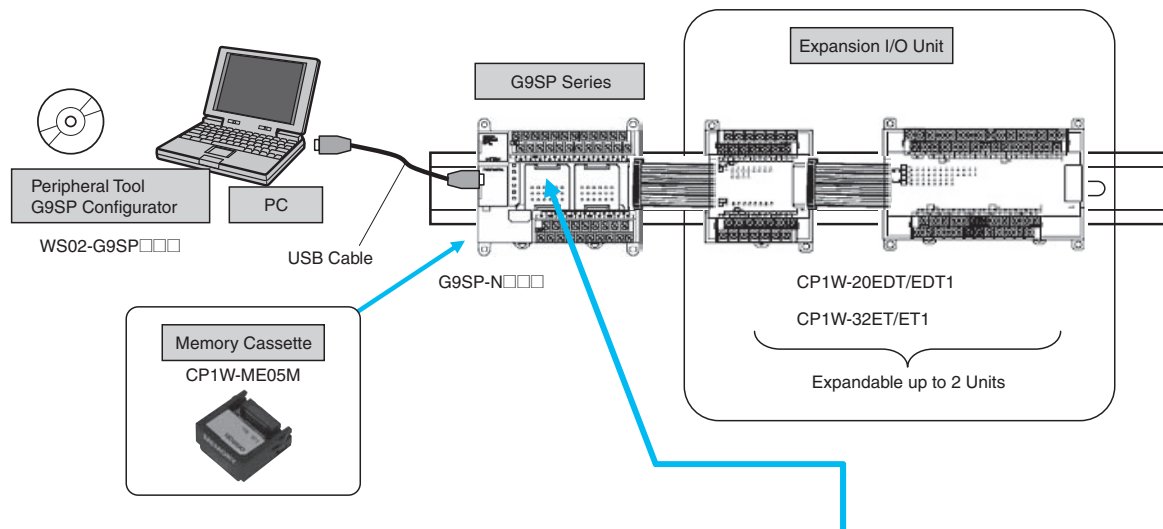

### ● When the Units are distantly-positioned such as one above the other layout

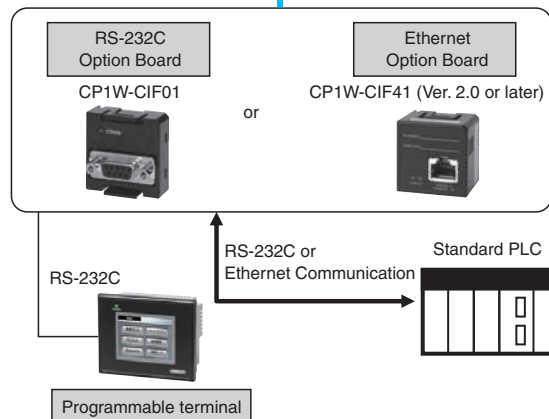
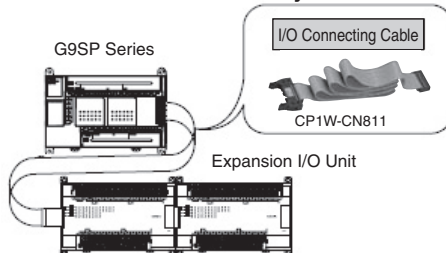

## Ordering Information

### G9SP Series

Name	Number of I/O				Unit version	Model
	Safety inputs	Test outputs	Safety outputs	Standard outputs		
Safety Controller	10	4	Solid-state outputs: 4	4	Ver.2.0	G9SP-N10S
	10	6	Solid-state outputs: 16	-		G9SP-N10D
	20	6	Solid-state outputs: 8	-		G9SP-N20S

### Expansion I/O Unit (for standard machine control)

Name	Type	Number of I/O		Model
		Inputs	Outputs	
Expansion I/O Unit	Sinking type	12	Solid-state outputs: 8	CP1W-20EDT
	Sourcing type			CP1W-20EDT1
	Sinking type	-	Solid-state outputs: 32	CP1W-32ET
	Sourcing type			CP1W-32ET1

**Note:** CP1W-CN811 I/O Connecting Cable is available.  
Refer to the Datasheet of CP1H Programmable Controller (Cat. No. P080-E1) for details.

### I/O Connecting Cable

Name	Specifications	Model
I/O Connecting Cable	80 cm (for the distantly-positioned units connection)	CP1W-CN811

**Note:** An I/O Connecting Cable (approx. 6 cm) for alongside setting is included in the Expansion I/O Unit package.

### Option Unit

Name	Model
RS-232C Option Board	CP1W-CIF01
Ethernet Option Board (Unit Ver. 2.0 or later)	CP1W-CIF41
Memory Cassette	CP1W-ME05M

**Note:** Refer to the Datasheet of CP1H Programmable Controller (Cat. No. P080-E1) for details.

### Configurator

Name	Media	Applicable OS	Model
G9SP Configurator	Setup Disk (CD-ROM: 1 license)	Windows XP (Service Pack 3 or higher, 64-bit edition not supported) Windows Vista (Service Pack 2 or later) Windows 7	WS02-G9SP01-V□
	Setup Disk (CD-ROM: 10 licenses)		WS02-G9SP10-V□
	Setup Disk (CD-ROM: 50 licenses)		WS02-G9SP50-V□
	Setup Disk (CD-ROM: Site license)		WS02-G9SPXX-V□

**Note:** 1. Administrator rights are required for installation.  
2. Operation is possible on the 64-bit editions of Windows Vista and Windows 7.

## Version Information

The combinations that can be used of the unit versions of the G9SP series and the version of Configurator.

G9SP series	G9SP Configurator	
Unit version Ver.1.□	Ver.1.□	Ver.2.00
Unit version Ver.2.0	---	Ver.2.00

## Function Support by Unit Version of G9SP

### Serial communication speed

Item	Unit Version	
	Ver.1.□	Ver.2.0
Communications protocol	No-protocol	
Communication speed	9,600 bps	9,600 bps 115,200 bps *
Transmission distance	max.15 m	max.15 m (With a baud rate of 115,200 bps: max.3 m)
Data length	8 bits	
Parity	Even	
Stop bits	1 bit	

\* The baud rate can be set to 115,200 bps with turning on the DIP switch pin 3.

### Connectivity with OMRON safety input devices

Item	Unit Version	
	Ver.1.□	Ver.2.0
Single-beam Safety Sensor E3ZS, E3FS	max.1 unit	G9SP-N10D/N20S: max.6 units G9SP-N10S : max.4 units
Non-contact Door Switch D40A, D40Z	G9SP-N10D/N20S: max.30 units G9SP-N10S : max.15 units	
Safety Mat UM	max.12 units	

## Programmable Terminal NB series

### Programmable Terminals

Product name	Specifications	Model
NB3Q	3.5 inch, TFT LCD, Color, 320 × 240 dots	NB3Q-TW00B
	3.5 inch, TFT LCD, Color, 320 × 240 dots, USB Host, Ethernet	NB3Q-TW01B
NB5Q	5.6 inch, TFT LCD, Color, 320 × 234 dots	NB5Q-TW00B
	5.6 inch, TFT LCD, Color, 320 × 234 dots, USB Host, Ethernet	NB5Q-TW01B
NB7W	7 inch, TFT LCD, Color, 800 × 480 dots	NB7W-TW00B
	7 inch, TFT LCD, Color, 800 × 480 dots, USB Host, Ethernet	NB7W-TW01B
NB10W	10.1 inch, TFT LCD, Color, 800 × 480 dots, USB Host, Ethernet	NB10W-TW01B

### Software

Product name	Specifications
Support Software for NB Series NB-Designer *	Supported Operating Systems: Windows 8, Windows 7, Windows Vista®, Windows XP (SP3 or higher). <b>Note:</b> Note: Except for Windows XP 64-bit version Download from Omron's regional websites.

\* NB-Designer version 1.32 or later can be used with G9SP.  
For detail, refer to the NB Series catalog (Cat. No. V412-E1).

## Specifications (Refer to Instruction Manual and Users Manual for details.)

### G9SP Series

#### General Specifications

Power supply voltage	24 VDC (20.4 to 26.4 VDC -15% +10%)
Current consumption *	G9SP-N10S: 400 mA (V1: 300 mA, V2: 100 mA) G9SP-N10D: 500 mA (V1: 300 mA, V2: 200 mA) G9SP-N20S: 500 mA (V1: 400 mA, V2: 100 mA)
Isolation class	Class III (SELV)
Overvoltage category	II
Noise immunity	Conforms to IEC61131-2
Vibration resistance	5 to 8.4 Hz: 3.5 mm, 8.4 to 150 Hz: 9.8 m/s <sup>2</sup>
Shock resistance	147 m/s <sup>2</sup> : 11 ms
Mounting	DIN track mounting (IEC60715 TH35-7.5/TH35-15) or M4 screws
Ambient operating temperature	0 to +55°C
Ambient operating humidity	10% to 90% (with no condensation)
Ambient storage temperature	-20°C to +75°C
Atmosphere	No corrosive gas
Operating altitude	2,000 m max.
Pollution degree	Pollution degree 2
Degree of protection	IP20 except terminal blocks
Terminal screws	M3 self-rising screws

\* Not including the current consumption of external devices.

Item	Model	G9SP-N10S	G9SP-N10D	G9SP-N20S
Safety inputs		10	10	20
Safety outputs		4	16	8
Test outputs		4	6	6
Standard outputs		4	-	-
Weight		290 g max.	440 g max.	430 g max.

#### Safety Input Specifications

Input type	Sinking inputs (PNP)
Input current	6 mA
ON voltage	11 VDC min. (between each input terminal and G1)
OFF voltage	5 VDC max. (between each input terminal and G1)
OFF current	1 mA max.

#### Test Output Specifications

Output type	Sourcing outputs (PNP)
Rated Output Current	G9SP-N10S
	T0, T1 : 60 mA max.
	T2 : 30 mA max. *1
	T3 : 300 mA max. *2
	T0-2 total : 60 mA max.
	G9SP-N10D
	T0, T1, T2 : 60 mA max.
	T3 : 300 mA max. *2
	T4, T5 : 30 mA max. *1
	Total of T0-2 and T4-5 : 60 mA max.
	G9SP-N20S
	T0, T1, T2 : 100 mA max.
T3 : 300 mA max. *2	
T4, T5 : 30 mA max. *1	
Total of T0-2 and T4-5 : 120 mA max.	
ON residual voltage	1.8 V max. (between each output terminal and V1)
Leakage current	0.1 mA max.

\*1. Connection to OMRON D40A/D40Z Non-contact Door Switch is possible.

\*2. With the Muting Lamp Output (open circuit detection)

#### Safety Output Specifications

Output type	Sourcing outputs (PNP)
Rated output current	0.8 A max./output 1.6 A max./4 outputs (G9SP-N10S/N20S) *1 1.2 A max./4 outputs (G9SP-N10D) *2
ON residual voltage	1.2 V max. (between each output terminal and V2)
OFF residual voltage	2 V max.
Leakage current	0.1 mA max.

\*1. Total current for So0 to So3 and So4 to So7

\*2. Total current for So0 to So3, So4 to So7, So8 to So11 and So12 to So15

**Note:** When a safety output is set as a pulse output, make sure that the connected devices do not malfunction due to the OFF pulse (pulse width: 640 μs).

#### Standard Output Specifications (G9SP-N10S)

Output type	Sourcing outputs (PNP)
ON residual voltage	1.5 V max. (between each output terminal and V2)
Rated output current	100 mA max.

## Configurator

### System Requirements

The following system is required to operate the G9SP Configurator. Make sure your system provides the following conditions and has the necessary components.

Item	Description
<b>CD-ROM or DVDROM drive</b>	One or more
<b>Supported operating systems</b>	Windows XP (Service Pack 3 or higher, except for 64-bit edition) Windows Vista (Service Pack 2 or higher) Windows 7 <b>Note:</b> 1. Administrator rights are required for installation. 2. Operation is possible on the 64-bit editions of Windows Vista and Windows 7.
<b>CPU</b>	Computer with a processor that is recommended by Microsoft Corporation.
<b>RAM</b>	Memory capacity that is recommended by Microsoft Corporation
<b>Required hard disk space</b>	200 MB min.
<b>Display</b>	High-luminance display of SVGA (800 × 600) min. With 256 colors min.
<b>Connection port to Controller</b>	USB port

### Certified Standards

Certifying body	Standard
<b>TÜV Rheinland</b>	EN ISO 13849-1 EN ISO 13849-2 IEC 61508 parts 1-7 EN 62061 IEC 61131-2 EN ISO 13850 EN 60204-1 EN 61000-6-2 EN 61000-6-4 NFPA 79 ANSI RIA R15.06 ANSI B11.19 ANSI/UL 1998
<b>UL</b>	UL508 CSA22.2 No.142
<b>KOSHA</b>	S Mark *

\* The G9SP-series Controller (version 1.1 or later) and the Expansion I/O Units have been certified for the KOSHA S Mark.



## Expansion I/O Unit

### Input Specifications (CP1W-20EDT/20EDT1)

Item	Specifications
Input voltage	24 VDC, +10%, -15%
Input impedance	4.7 kΩ
Input current	5 mA TYP
ON voltage	14.4 VDC min.
OFF voltage	5.0 VDC max.
ON delay	1 ms max. *
OFF delay	1 ms max. *

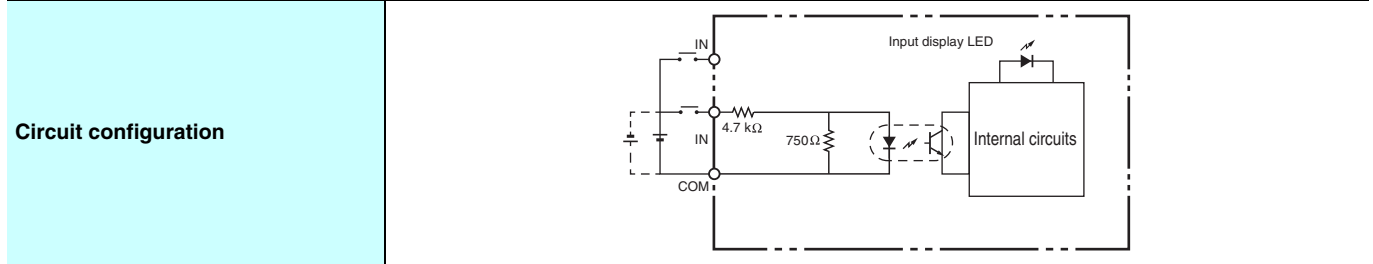

\*ON/OFF delay represents the hardware delay time.

### Output Specifications (Transistor outputs: sinking/sourcing type)

Item	Specifications	
	CP1W-20EDT/EDT1	CP1W-32ET/32ET1
Maximum switching capacity *1	24 VDC +10%, -5% 0.3 A/output	4.5 to 30 VDC 0.3 A/output
	0.9 A/common 1.8 A/unit	0.9 A/common 7.2 A/unit
Leakage current	0.1 mA max.	0.1 mA max.
Residual voltage	1.5 V max.	1.5 V max.
ON delay	0.1 ms max.	0.1 ms max.
OFF delay	1 ms max. 24 VDC, +10%, -5%, when 5 to 300 mA	1 ms max. 24 VDC, +10%, -5%, when 5 to 300 mA
Maximum number of outputs for simultaneous ON	8 outputs (100% load)	24 outputs (75% load)
Fuse #2	1/common	

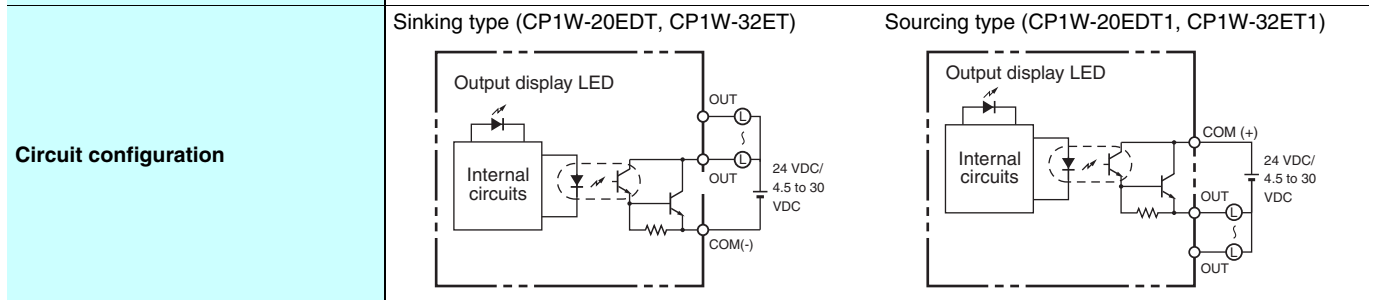

\*1. A maximum of 0.9 A per common can be switched at an ambient temperature of 50°C.

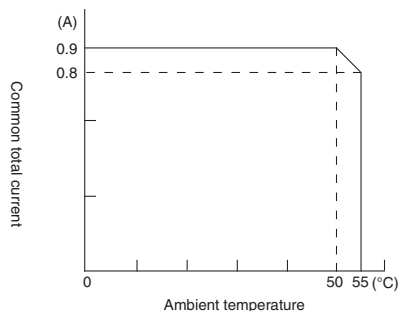

\*2. User cannot replace fuses. Replace the unit if a fuse blows due to short circuit, etc.

## Option Unit

### RS-232C Option Board (CP1W-CIF01)

#### Communication Specifications

Item	Specifications
Connection method	D-SUB 9P (female)
Maximum transmission distance	With a baud rate of 9,600 bps: 15m With a baud rate of 115,200 bps: 3m
Communication protocol	No-protocol
Maximum data length	Refer to the Users Manual for details.
Communication settings	Baud rate 9,600 or 115,200 bps (unit version 2.0 or later)

## Ethernet Option Board (CP1W-CIF41 unit ver. 2.0 or later)











#### Ethernet Communication Specifications

Item	Specifications	
Name	CP Series Ethernet Option Board	
Model	CP1W-CIF41	
Type	100 BASE-TX (applicable as a 10 BASE-T)	
Transmission specifications	Media access method	CSMA/CD
	Modulation method	Baseband
	Transmission path type	Star form
	Baud rate	100 Mbps (100 BASE-TX)   10 Mbps (10 BASE-T) Internal transmission speed between G9SP and Ethernet Option Board is of 115.2 kbps.
	Transmission media	Unshielded twisted-pair (UDP) cable Categories: 5, 5e   Unshielded twisted-pair (UDP) cable Categories: 3, 4, 5, 5e Shielded twisted-pair (STP) cable Categories: 100 Ω at 5, 5e   Shielded twisted-pair (STP) cable Categories: 100 Ω at 3, 4, 5, 5e
	Transmission distance	100 m (distance between hub and node)
	Number of cascade-connectable units	No limit when a switching hub is used.
Weight	23 g max.	
Dimensions	36.4 (W) x 36.4 (H) x 28.2 (D) mm	







## Functions (Refer to the Instructions Reference Manual (Cat. No. Z923-E1) for details.)

### Function Blocks













#### Logic Functions

Function Block Name	Notation on Function List	Icon	Details
NOT	NOT		Outputs the logical complement of the input condition.
AND	AND		Outputs the logical AND of the input conditions.
OR	OR		Outputs the logical OR of the input conditions.
NAND	NAND		Outputs the logical NAND of the input conditions.
NOR	NOR		Outputs the logical NOR of the input conditions.
Exclusive OR	EXOR		Outputs the exclusive OR of the input conditions.
Exclusive NOR	EXNOR		Outputs the exclusive NOR of the input conditions.
RS-FF (Reset Set Flip-Flop)	RS-FF		When the input signal turns ON, RS-FF holds the ON status in the function block and continuously connects to the output.
Comparator	Comparator		Compares the input signals to the set value and turns ON the output if they match.
Comparator 2	Comparator2		Compares the input signals to the set value and outputs the comparison result.



#### Timer/Counter Functions

Function Block Name	Notation on Function List	Icon	Details
Off-Delay Timer	Off-Delay Timer		Operates an OFF-delay timer.
On-Delay Timer	On-Delay Timer		Operates an ON-delay timer.
Pulse Generator	Pulse Generator		Cyclically outputs ON/OFF pulses on the Output Enable while the input signal is ON.
Counter	Counter		Counts the number of input signals and turns ON the output when the count reaches the specified number.
Up-Down Counter	Up-Down Counter		Increments the counter on the leading edge of an up count input and decrements the counter on the leading edge of a down count input.
Serial-Parallel Converter	Serial-Parallel Converter		Counts the number of input signals and outputs the count value.



## Safety Device Function Blocks

Function Block Name	Notation on Function List	Icon	Details
External Device Monitoring	EDM		Evaluates the input signal and external device status and sends a safety output to the external device. This function block is used to detect fused contacts or external wiring problems (disconnected lines) for safety relays, contactors, and other safety devices.
Enable Switch Monitoring	Enable Switch	 Enable	Monitors the status of an Enable Switch device.
Emergency Stop Switch Monitoring	E-Stop		Monitors the status of an Emergency Stop Switch.
Light Curtain Monitoring	Light Curtain Monitoring		Monitors the input signal from a Safety Light Curtain.
Muting	Muting	 Mute	Temporarily disables the input signals for a Light Curtain when the muting signal is detected.
Safety Gate Monitoring	Safety Gate Monitoring		Monitors the status of a safety door (Safety-door Switch or Safety Limit Switch). This function block can be used to set function tests for Safety Category 2.
Two Hand Controller	Two Hand Controller		Monitors the status of a Two-hand Switch.
User Mode Switch Monitoring	User Mode Switch		Monitors the operating mode switch for a user system or device.
Redundant Input Monitoring	Redundant Input		Monitors for discrepancies in two input signals.
Single Beam Safety Sensor	Single Beam Safety Sensor		Monitors the input signal of an OMRON E3ZS/E3FS Single-beam Safety Sensor.
Non-Contact Door Switch Monitoring	Non-Contact Door Switch		Monitors an OMRON D40A/D40Z Non-contact Door Switch.
Safety Mat Monitoring	Safety Mat		Monitors an OMRON UM Safety Mat.

## Reset and Restart Function Blocks

Function Block Name	Notation on Function List	Icon	Details
Reset	Reset	 RESET	Outputs ON if the reset signal is correctly input while the input condition is ON. This function block can be used to prevent equipment from starting automatically.
Restart	Restart	 Restart	Performs the same operation as a Reset function block. The icon is different.

## Connector Function Blocks

Function Block Name	Notation on Function List	Icon	Details
Multi Connector	Multi Connector		Outputs the status of the input signals.
Routing	Routing		Distributes an input signal to multiple signals.

# Wiring

## Terminal Arrangement

### G9SP-N10S

Top (17 pin)

V1	G1	Si1	Si3	Si5	Si7	Si9	T1	T3
NC	Si0	Si2	Si4	Si6	Si8	T0	T2	

Bottom (14 pin)

NC	So0	So2	O0	O2	NC	NC
V2	G2	So1	So3	O1	O3	NC

### G9SP-N10D

Top (24 pin)

V1	G1	Si1	Si3	Si5	Si7	Si9	NC	NC	T1	T3	T5
NC	Si0	Si2	Si4	Si6	Si8	NC	NC	T0	T2	T4	NC

Bottom (19 pin)

NC	So0	So2	So4	So6	So8	So10	So12	So14	
V2	G2	So1	So3	So5	So7	So9	So11	So13	So15

### G9SP-N20S

Top (24 pin)

V1	G1	Si1	Si3	Si5	Si7	Si9	Si11	Si13	Si15	Si17	Si19
NC	Si0	Si2	Si4	Si6	Si8	Si10	Si12	Si14	Si16	Si18	NC

Bottom (19 pin)

NC	So0	So2	So4	So6	NC	T0	T2	T4	
V2	G2	So1	So3	So5	So7	NC	T1	T3	T5

Terminals	Function
V1/G1	Power supply terminals for Internal/Input circuits (24 VDC)
V2/G2	Power supply terminals for output circuits (24 VDC)
NC	Not used (Do not connect.)
Si0 - Si19	Safety input terminals
T0 - T5	Test output terminals
So0 - So15	Safety output terminals
O0 - O3	Standard output terminals

## Internal Circuits and Wiring Example

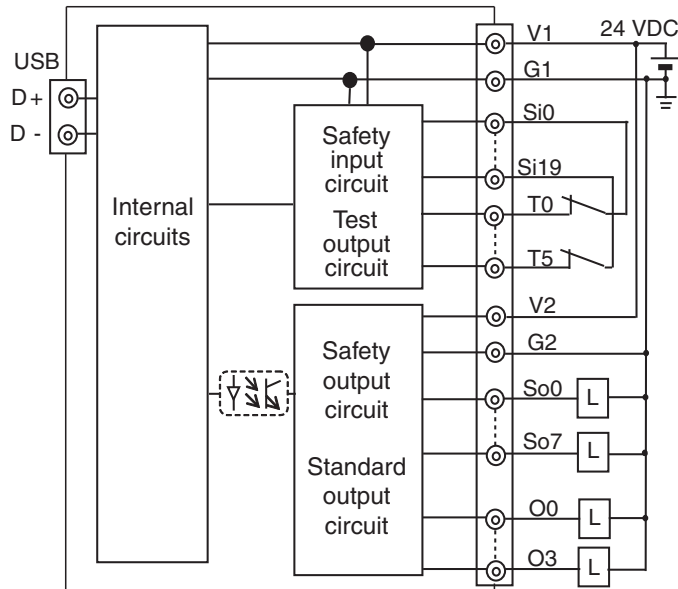

## I/O Wiring Example: Emergency Stop (Dual Channel) with Manual Reset

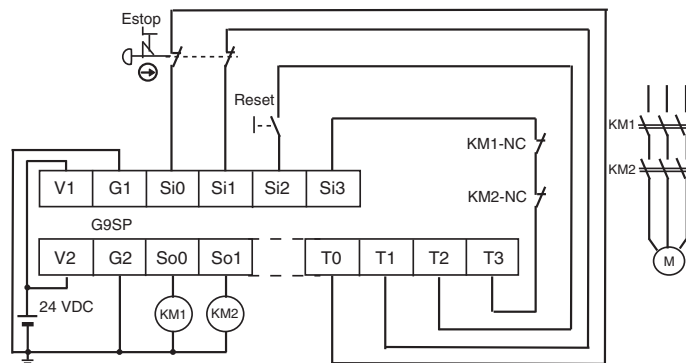

## Application Templates

### Emergency Stop Pushbutton Application

PL/Safety Category	Model	Stop category	Reset
PLe/4 equivalent	Emergency stop pushbutton A165E/A22E	0	Manual

#### Application Overview

The power supply to motor M is turned OFF when emergency stop switch S1 is pressed.

#### Wiring Example

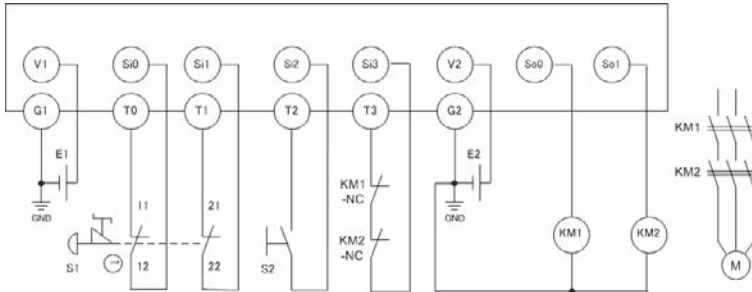

- E1 and E2: 24-VDC power supplies
- S1: Emergency stop switch
- S2: Reset switch
- KM1 and KM2: Contactors
- M: Motor

**Note:** Refer to page 20 for the terminal arrangement.

#### Timing Chart

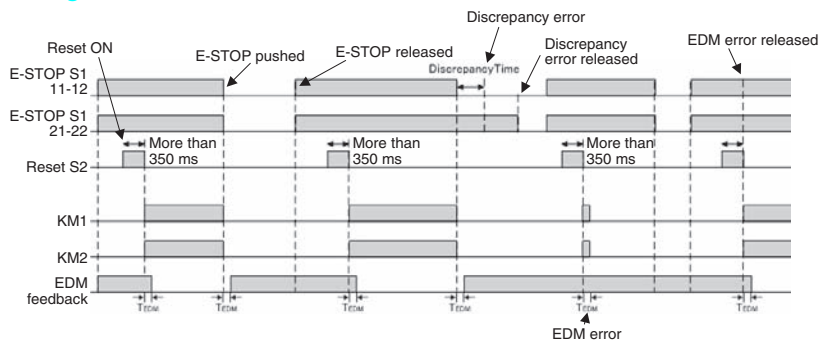

#### Safety I/O Terminal Settings

##### Input Terminals

Ter...	Name of settings	I/O Comment	Test Source
S10	Emergency Stop S...	EMO NC S1 11-12	T0
S11		EMO NC S1 21-22	T1
S12	Reset Switch	Reset S2	T2
S13	EDM(Contact Weld...	Feedback KM1_KM2...	T3

##### Output Terminals

Ter...	Name of settings	I/O Comment
SoU	2 Safety Relays w/ welding ...	contactor KM1
So1		contactor KM2

#### Program

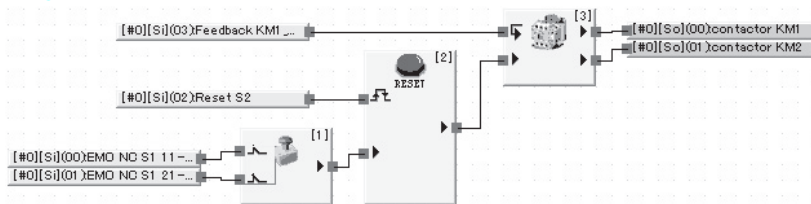

#### Precautions for Safe Use

- Perform a function test every six months to detect contact welding failures on contactors.
- It is the user's responsibility to make sure that the entire system complies with standards.
- For safety reasons, two electrical switching elements and two relays or contactors are always necessary to detect electrical faults and mechanical faults.

## Safety Light Curtain Application

PL/Safety Category	Model	Stop category	Reset
PLe/4 equivalent	<ul style="list-style-type: none"> <li>Emergency stop pushbutton A165E/A22E</li> <li>Safety light curtain F3SJ-E□□□□P25</li> <li>Safety Limit Switch D4N/D4F</li> </ul>	0	Manual

### Application Overview

The power supply to the motor is turned OFF when light is intercepted in the safety light curtain and the safety limit switch turns OFF simultaneously. The output also goes OFF when emergency switch S1 is pressed.

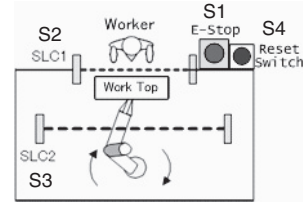

### Wiring Example

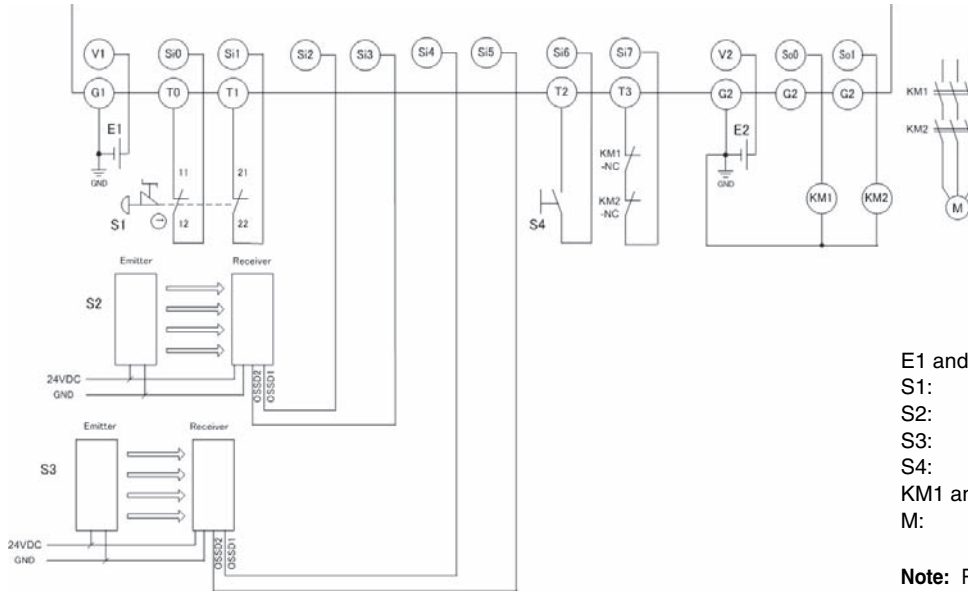

- E1 and E2: 24-VDC power supplies
- S1: Emergency stop switch
- S2: Safety light curtain
- S3: Safety limit switch
- S4: Reset switch
- KM1 and KM2: Contactors
- M: Motor

**Note:** Refer to page 20 for the terminal arrangement.

### Timing Chart

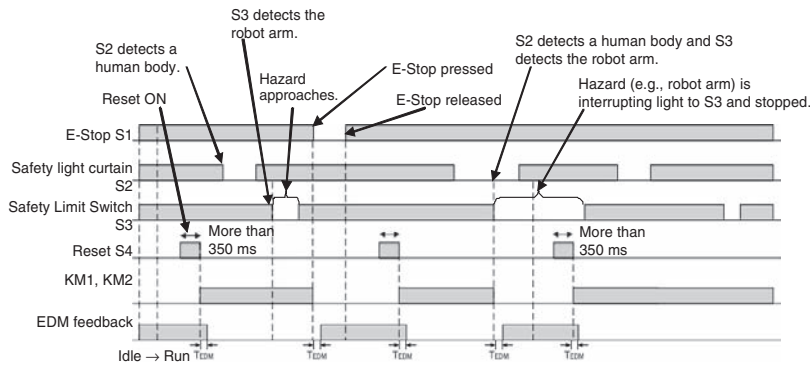

### Safety I/O Terminal Settings

#### Input Terminals

Ter...	Name of settings	I/O Comment	Test Source
S10	Emergency Stop S...	EMO NC S1 11-12	T0
S11		EMO NC S1 21-22	T1
S12	Light Curtain	Light curtain	
S13		Light curtain	
S14	Light Curtain	Limit Switch	
S15		Limit Switch	
S16	Reset Switch	Reset S4	T2
S17	EDM(Contact Wel...	Feedback KM1_KM2...	T3

#### Output Terminals

Ter...	Name of settings	I/O Comment
So0	2 Safety Relays w/ welding ...	contactor KM1
So1		contactor KM2

### Program

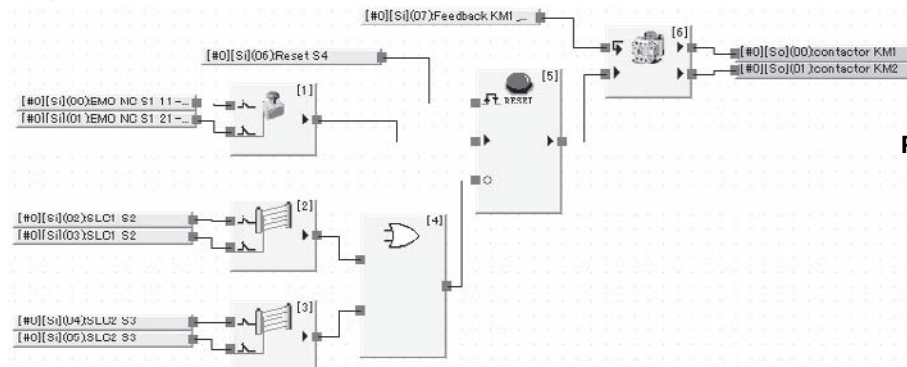

### Precautions for Safe Use

- Perform a function test every six months to detect contact welding failures on contactors.
- It is the user's responsibility to make sure that the entire system complies with standards.
- For safety reasons, two electrical switching elements and two relays or contactors are always necessary to detect electrical faults and mechanical faults.

## D40A Non-Contact Switch Application

PL/Safety Category	Model	Stop category	Reset
PLe/4 equivalent	<ul style="list-style-type: none"> <li>Emergency stop pushbutton A165E/A22E</li> <li>Non-Contact Door Switch D40Z</li> </ul>	0	Manual

### Application Overview

The power supply to motor M is turned OFF when emergency stop switch S1 is pressed.  
The power supply to motor M is turned OFF by opening safety door S2.

### Wiring Example

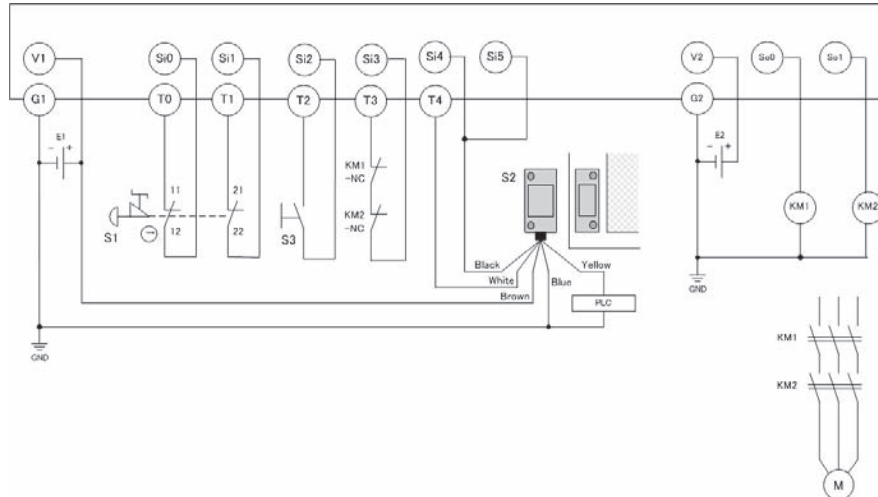

- E1 and E2: 24-VDC power supplies
- S1: Emergency stop pushbutton
- S2: D40A Non-contact Switch
- S3: Reset switch
- KM1 and KM2: Contactors
- M: Motor

Note: Refer to page 20 for the terminal arrangement.

### Timing Chart

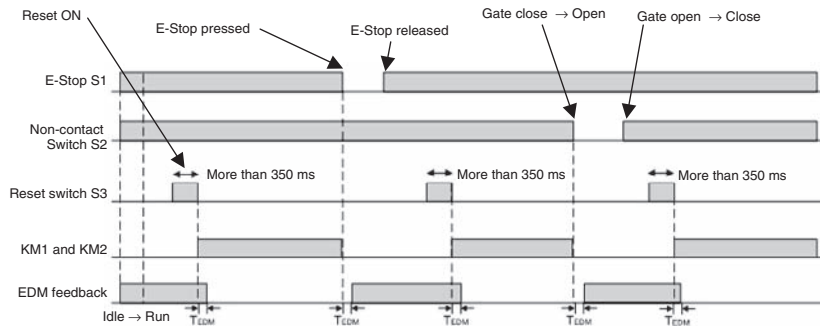

### Safety I/O Terminal Settings

#### Input Terminals

Ter...	Name of settings	I/O Comment	Test Source
Si0	Emergency Stop Sw...	EMO NC S1 11-12	T0
Si1		EMO NC S1 21-22	T1
Si2	Reset Switch	Reset S3	T2
Si3	EDM(Contact Weldi...	Feedback KM1_KM2	T3
Si4	Non-contact Switch	Non-contact Switch...	T4
Si5		Non-contact Switch...	T4

#### Output Terminals

Ter...	Name of settings	I/O Comment
So0	2 Safety Relays w/ welding ...	contactor KM1
So1		contactor KM2

### Program

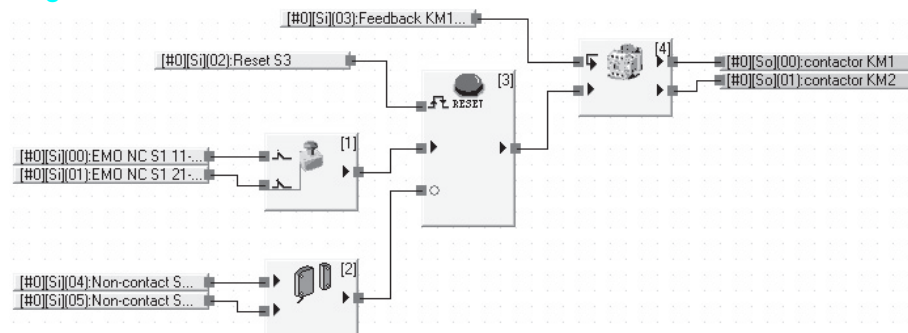

### Precautions for Safe Use

- Perform a function test every six months to detect contact welding failures on contactors.
- It is the user's responsibility to make sure that the entire system complies with standards.
- For safety reasons, two electrical switching elements and two relays or contactors are always necessary to detect electrical faults and mechanical faults.



# Dimensions

## Safety Controller G9SP-N10S

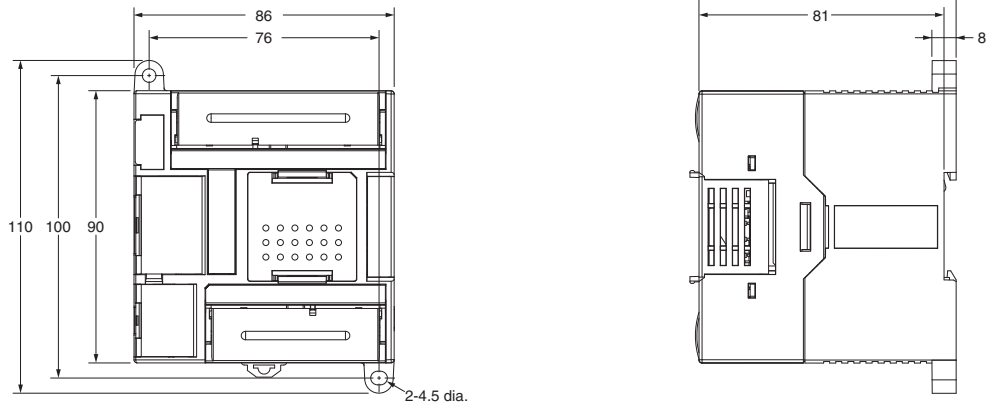

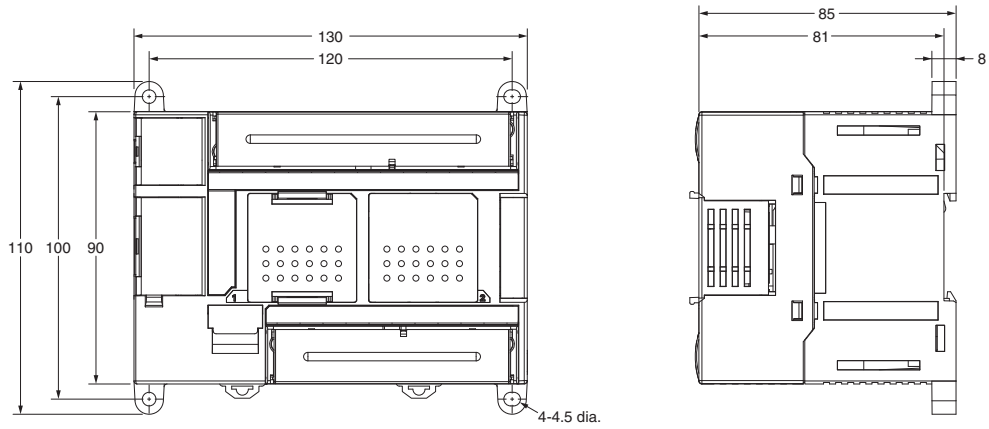

## Safety Controller G9SP-N10D G9SP-N20S





## Safety Precautions

### Meanings of Signal Words

 <b>WARNING</b>	Indicates a potentially hazardous situation which, if not avoided, will result in minor or moderate injury, or may result in serious injury or death. Additionally there may be significant property damage.
 <b>CAUTION</b>	Indicates a potentially hazardous situation which, if not avoided, will result in minor or moderate injury, or there may be property damage.

### Meaning of Alert Symbols

	Indicates prohibited actions.
	Indicates mandatory actions.

 <b>WARNING</b>
Electric shock may occur. Do not touch any terminals while power is being supplied. 

<p> <b>Serious injury may possibly occur due to loss of required safety functions. Do not use the G9SP-series Controller's test outputs or standard outputs as safety outputs.</b>  </p>
---

<p> <b>Serious injury may possibly occur due to loss of required safety functions. Do not use the G9SP-series Controller's network data as safety data.</b>  </p>
--

<p> <b>Serious injury may possibly occur due to loss of required safety functions. Do not use indicators on the G9SP-series Controller for safety operations.</b>  </p>
--

<p> <b>Serious injury may possibly occur due to breakdown of safety outputs or test outputs. Do not connect loads beyond the rated values to the safety outputs and test outputs.</b>  </p>
--

<p> <b>Serious injury may possibly occur due to loss of required safety functions. Wire the G9SP-series Controller properly so that the 24 VDC line does NOT touch the outputs accidentally or unintentionally.</b>  </p>
--

<p> <b>Serious injury may possibly occur due to loss of required safety functions. Ground the 0V line of the power supply for external output devices so that the devices do NOT turn ON when the safety output line or the test output line is grounded.</b>  </p>
--

<p> <b>Serious injury may possibly occur due to loss of required safety functions. Perform user testing and confirm that all of the G9SP-series Controller's configuration data and operation is correct before starting system operation.</b>  </p>
---

<p> <b>Serious injury may possibly occur due to loss of required safety functions. When replacing a G9SP-series Controller, confirm the model of the Controller is correct and configure the replacement Controller suitably and confirm that it operates correctly.</b>  </p>
---

<p> <b>Serious injury may possibly occur due to loss of required safety functions. When the configuration data is restored by using a Memory Cassette, a test must be performed to confirm that the safety devices function correctly.</b>  </p>
---

<p> <b>Outputs may operate, possibly resulting in serious injury. Take sufficient safety measures before force-setting or force-resetting variables in the program.</b>  </p>
--

<p> <b>Serious injury may possibly occur due to loss of required safety functions. Use devices and parts related to safety functions according to legal regulations in the applicable country. Use certified items compliant with safety standards corresponding to the intended application.</b>  </p>
--

### Precautions for Safe Use

#### Handle with Care

Do not drop the G9SP-series Controller or subject it to excessive vibration or mechanical shock. The G9SP-series Controller may be damaged and may not function properly.

#### Installation and Storage Environment

Do not use or store the G9SP-series Controller in any of the following locations:

- Locations subject to direct sunlight
- Locations subject to temperatures or humidity outside the range specified in the specifications
- Locations subject to condensation as the result of severe changes in temperature
- Locations subject to corrosive or flammable gases
- Locations subject to dust (especially iron dust) or salts
- Locations subject to water, oil, or chemicals
- Locations subject to shock or vibration

Take appropriate and sufficient measures when installing systems in the following locations. Inappropriate and insufficient measures may result in malfunction.

- Locations subject to static electricity or other forms of noise
- Locations subject to strong electromagnetic fields
- Locations subject to possible exposure to radioactivity
- Locations close to power supplies

This is a class A product designed for use in industrial environments. In residential areas it may cause radio interference, in which case the user may be required to take adequate measures to reduce interference.

- Use the G9SP-series Controller within an enclosure with IP54 protection or higher according to IEC/EN 60529.

- Use DIN Track (TH35-7.5/TH35-15 according to IEC 60715) or M4 screws with a tightening torque of 1.2 N·m (10.5 lb·in) to install the G9SP-series Controller into the control panel.
- Mount the G9SP-series Controller to the DIN Track using PFP-M End Plates (not included with the G9SP-series Controller) to prevent it from falling off the DIN Track because of vibration. Correctly mount all Units to DIN Track.
- Install the G9SP-series Controller in the vertical direction shown below to ensure adequate cooling.

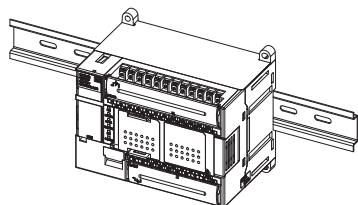

- Space must be provided around the G9SP-series Controller, at least 20 mm from its side surfaces and at least 50 mm from its top and bottom surfaces, for ventilation and wiring.
- Be sure to lock all locking mechanisms, such as those on I/O terminal blocks and connectors, before attempting to use the Controller.

Turn OFF the power supply before performing any of the following.

- Connecting or disconnecting Expansion I/O Units, Option Boards, or any other Units
- Assembling the Controller
- Connecting cables or wiring
- Connecting or removing terminal blocks

## Installation and Wiring

- Use the following to wire external I/O devices to the G9SP-series Controller.

<b>Solid wire</b>	0.32 to 0.82 mm <sup>2</sup> AWG22 to AWG18 0.32 to 0.5 mm <sup>2</sup> AWG22 to AWG20 *
<b>Stranded wire</b>	0.5 to 1.3 mm <sup>2</sup> AWG20 to AWG16 0.5 to 0.82 mm <sup>2</sup> AWG20 to AWG18 *

\*When wiring two wires to one terminal. Use two wires of the same type and thickness.

- Tighten the terminal block screws to a torque of 0.5 N·m.
- Disconnect the G9SP-series Controller from the power supply before starting wiring. Devices connected to the G9SP-series Controller may operate unexpectedly.
- Properly apply the specified voltage to the G9SP-series Controller inputs. Applying an inappropriate DC voltage or any AC voltage will cause the G9SP-series Controller to fail.
- Be sure to separate the communications cables and I/O cables from high-voltage/high-current lines.
- Be cautious not to get your fingers caught when attaching connectors to the plugs on the G9SP-series Controller.
- Incorrect wiring may lead to loss of safety functions. Wire conductors correctly and verify the operation of the G9SP-series Controller before using the system in which the G9SP-series Controller is incorporated.
- Lock the connectors on Option Units or Expansion I/O Unit before using the Units.
- After wiring is completed, be sure to remove the label for wire clip entry prevention from the G9SP-series Controller to enable heat to escape for proper cooling.

- Do not ground the 24-V side of the power supply to the G9SP-series Controller. If you do so, an unwanted current flow shown in the following diagram may occur when you connect a computer or other peripheral device.

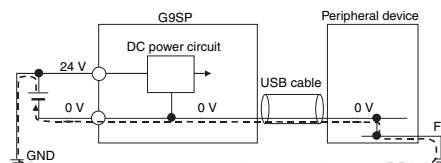

- Do not connect the Expansion I/O Units over the specified number.

## Power Supply Selection

Use a DC power supply satisfying the following requirements.

- The secondary circuit of the DC power supply must be isolated from the primary circuit by double insulation or reinforced insulation.
- The isolated power supply with a current limited to 8 A.
- The output hold time must be 20 ms or longer.
- The DC power supply must be an SELV power supply that satisfies the requirements of IEC/EN 60950-1 and EN 50178.

## Periodic Inspections and Maintenance

- Disconnect the G9SP-series Controller from the power supply before replacing the Controller. Devices connected to the G9SP-series Controller may operate unexpectedly.
- Do not disassemble, repair, or modify the G9SP-series Controller. Doing so may lead to loss of safety functions.

## Disposal

- Be cautious not to injure yourself when dismantling the G9SP-series Controller.



---

**MEMO**



## **READ AND UNDERSTAND THIS CATALOG**

Please read and understand this catalog before purchasing the products. Please consult your OMRON representative if you have any questions or comments.

## **Warranty and Limitations of Liability**

### **WARRANTY**

OMRON's exclusive warranty is that the products are free from defects in materials and workmanship for a period of one year (or other period if specified) from date of sale by OMRON.

OMRON MAKES NO WARRANTY OR REPRESENTATION, EXPRESS OR IMPLIED, REGARDING NON-INFRINGEMENT, MERCHANTABILITY, OR FITNESS FOR PARTICULAR PURPOSE OF THE PRODUCTS. ANY BUYER OR USER ACKNOWLEDGES THAT THE BUYER OR USER ALONE HAS DETERMINED THAT THE PRODUCTS WILL SUITABLY MEET THE REQUIREMENTS OF THEIR INTENDED USE. OMRON DISCLAIMS ALL OTHER WARRANTIES, EXPRESS OR IMPLIED.

### **LIMITATIONS OF LIABILITY**

OMRON SHALL NOT BE RESPONSIBLE FOR SPECIAL, INDIRECT, OR CONSEQUENTIAL DAMAGES, LOSS OF PROFITS OR COMMERCIAL LOSS IN ANY WAY CONNECTED WITH THE PRODUCTS, WHETHER SUCH CLAIM IS BASED ON CONTRACT, WARRANTY, NEGLIGENCE, OR STRICT LIABILITY.

In no event shall responsibility of OMRON for any act exceed the individual price of the product on which liability is asserted.

IN NO EVENT SHALL OMRON BE RESPONSIBLE FOR WARRANTY, REPAIR, OR OTHER CLAIMS REGARDING THE PRODUCTS UNLESS OMRON'S ANALYSIS CONFIRMS THAT THE PRODUCTS WERE PROPERLY HANDLED, STORED, INSTALLED, AND MAINTAINED AND NOT SUBJECT TO CONTAMINATION, ABUSE, MISUSE, OR INAPPROPRIATE MODIFICATION OR REPAIR.

## **Application Considerations**

### **SUITABILITY FOR USE**

OMRON shall not be responsible for conformity with any standards, codes, or regulations that apply to the combination of products in the customer's application or use of the product.

At the customer's request, OMRON will provide applicable third party certification documents identifying ratings and limitations of use that apply to the products. This information by itself is not sufficient for a complete determination of the suitability of the products in combination with the end product, machine, system, or other application or use.

The following are some examples of applications for which particular attention must be given. This is not intended to be an exhaustive list of all possible uses of the products, nor is it intended to imply that the uses listed may be suitable for the products:

- Outdoor use, uses involving potential chemical contamination or electrical interference, or conditions or uses not described in this document.
- Nuclear energy control systems, combustion systems, railroad systems, aviation systems, medical equipment, amusement machines, vehicles, safety equipment, and installations subject to separate industry or government regulations.
- Systems, machines, and equipment that could present a risk to life or property.

Please know and observe all prohibitions of use applicable to the products.

NEVER USE THE PRODUCTS FOR AN APPLICATION INVOLVING SERIOUS RISK TO LIFE OR PROPERTY WITHOUT ENSURING THAT THE SYSTEM AS A WHOLE HAS BEEN DESIGNED TO ADDRESS THE RISKS, AND THAT THE OMRON PRODUCT IS PROPERLY RATED AND INSTALLED FOR THE INTENDED USE WITHIN THE OVERALL EQUIPMENT OR SYSTEM.

## **Disclaimers**

### **CHANGE IN SPECIFICATIONS**

Product specifications and accessories may be changed at any time based on improvements and other reasons.

It is our practice to change model numbers when published ratings or features are changed, or when significant construction changes are made. However, some specifications of the product may be changed without any notice. When in doubt, special model numbers may be assigned to fix or establish key specifications for your application on your request. Please consult with your OMRON representative at any time to confirm actual specifications of purchased products.

### **DIMENSIONS AND WEIGHTS**

Dimensions and weights are nominal and are not to be used for manufacturing purposes, even when tolerances are shown.

### **ERRORS AND OMISSIONS**

The information in this document has been carefully checked and is believed to be accurate; however, no responsibility is assumed for clerical, typographical, proofreading errors, or omissions.

### **PERFORMANCE DATA**

Performance data given in this catalog is provided as a guide for the user in determining suitability and does not constitute a warranty. It may represent the result of OMRON's test conditions, and the users must correlate it to actual application requirements. Actual performance is subject to the OMRON Warranty and Limitations of Liability.

### **PROGRAMMABLE PRODUCTS**

OMRON shall not be responsible for the user's programming of a programmable product, or any consequence thereof.

## **Copyright and Copy Permission**

### **COPYRIGHT AND COPY PERMISSION**

This document shall not be copied for sales or promotions without permission.

This document is protected by copyright and is intended solely for use in conjunction with the product. Please notify us before copying or reproducing this document in any manner, for any other purpose. If copying or transmitting this document to another, please copy or transmit it in its entirety.

**OMRON Corporation Industrial Automation Company**

Tokyo, JAPAN

Contact: [www.ia.omron.com](http://www.ia.omron.com)

**Regional Headquarters**

**OMRON EUROPE B.V.**

Wegalaan 67-69-2132 JD Hoofddorp  
The Netherlands

Tel: (31)2356-81-300/Fax: (31)2356-81-388

**OMRON SCIENTIFIC TECHNOLOGIES INC.**

6550 Dumbarton Circle, Fremont  
CA 94555-3605 U.S.A.

Tel: (1) 510-608-3400/Fax: (1) 510-744-1442

**OMRON ASIA PACIFIC PTE. LTD.**

No. 438A Alexandra Road # 05-05/08 (Lobby 2),  
Alexandra Technopark,  
Singapore 119967

Tel: (65) 6835-3011/Fax: (65) 6835-2711

**OMRON (CHINA) CO., LTD.**

Room 2211, Bank of China Tower,  
200 Yin Cheng Zhong Road,  
PuDong New Area, Shanghai, 200120, China

Tel: (86) 21-5037-2222/Fax: (86) 21-5037-2200

**Authorized Distributor:**

© OMRON Corporation 2010 All Rights Reserved.  
In the interest of product improvement,  
specifications are subject to change without notice.  
CSM\_9\_2\_0614

**Cat. No. F090-E1-01**

Printed in Japan  
(0619)